



# Service Guide: Power Supply Model 153941 (002-2018-XX)

## Contents:

Accessing the Power Supply .....	1
Replacing Fuses.....	2
Wiring Diagrams.....	3 & 4
Wire Color	
Abbreviation Chart.....	5

### Note

The Power Supply, converts, regulates and distributes electric power from the electrical mains supply to components installed on Midmark Dental Chairs.

## Accessing the Power Supply



### DANGER - WARNING

To prevent the possibility of electrical shock, always disconnect electrical mains supply to the Power Supply before removing the cover. Failure to comply with these instructions could result in severe personal injury or deaths.

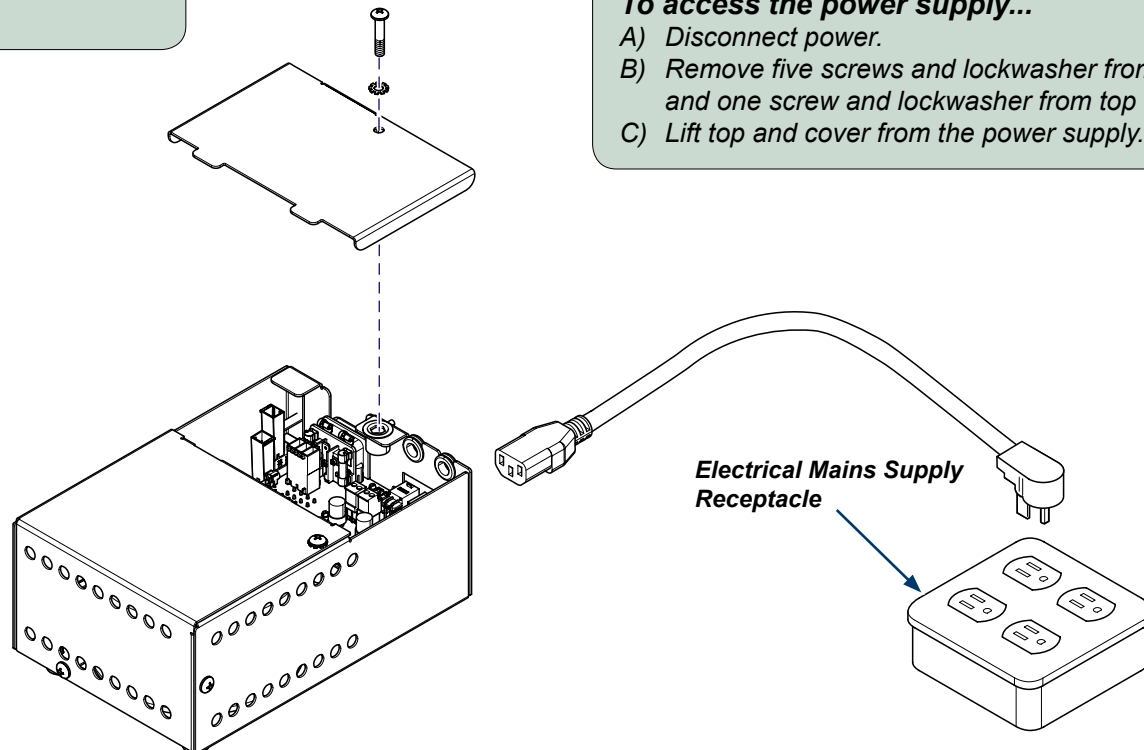

### To access the power supply...

- Disconnect power.
- Remove five screws and lockwasher from top and one screw and lockwasher from top cover.
- Lift top and cover from the power supply.

## Replacing Fuses



### **DANGER - WARNING**

To prevent the possibility of electrical shock, always disconnect electrical mains supply to the Power Supply before removing the cover. Failure to comply with these instructions could result in severe personal injury or deaths.

### **To replace fuses...**

- A) Disconnect power.
- B) Remove cover and top. (Reference Accessing the Power Supply.)
- C) Extract fuse(s) to be replaced.
- D) Install new fuse(s).
- E) Install cover and top then secure with screws and lock washers.
- F) Reconnect powercord to the power supply.

Note: Lift straight up to remove button type fuses.

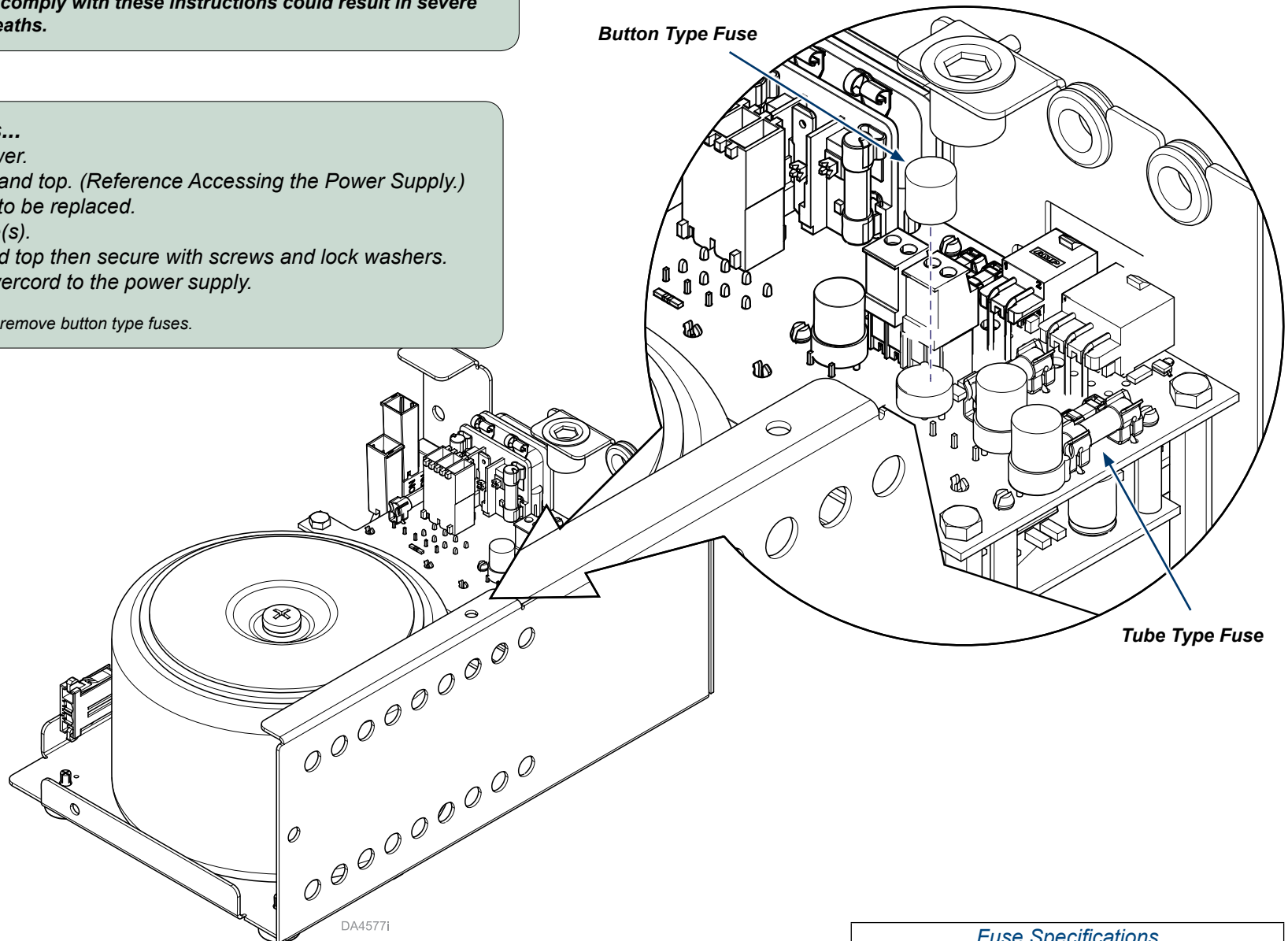

# Wiring Diagram - Power Supply Assembly

**Note** All leads come out the same side of the transformer.



## Equipment Alert

Use care to prevent static discharge when handling PC Boards.

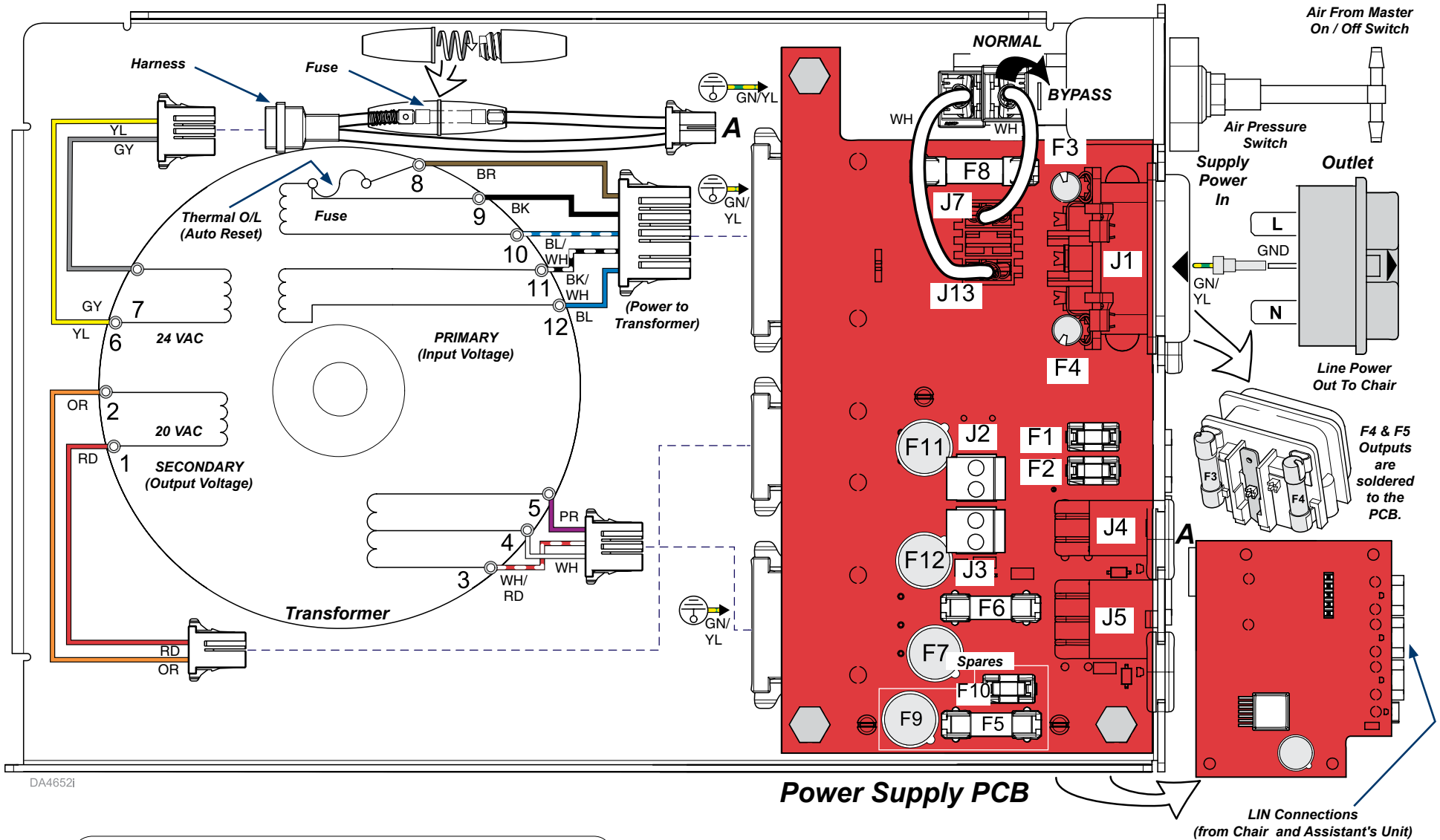

DA46521



## Equipment Alert

230 V~ model requires air pressure to activate chair. If air pressure is unavailable, then plug chair power into supply power cord.

[Fuse Specifications](#)

[Color Abbreviation Chart](#)

Description	Part Number
Harness (Refer to "A" for other connection)	015-3413-00

# Wiring Diagram - Power Supply Assembly (End View)

PSI	kpa
30	206.8
50	344.7
80	551.6
100	689.5

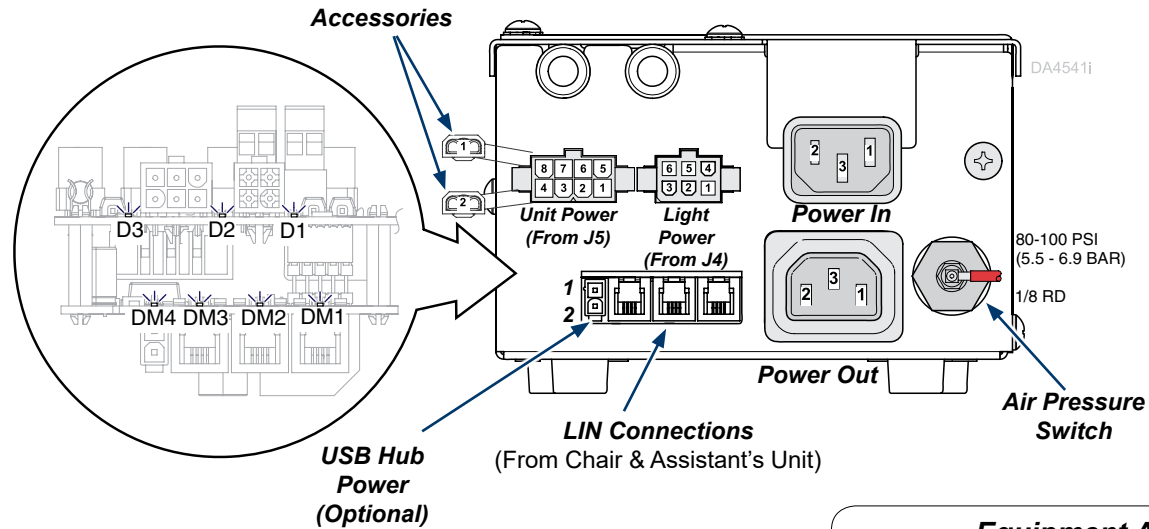

## Note:

LIN Gnd = Chair Control DCV Ground reference.  
 PE Gnd = Protective Earth Ground.  
 N/A = Not Applicable.



## Equipment Alert

230 V~ model requires air pressure to activate chair.  
 If air pressure is unavailable, plug chair power into supply power cord.

## POWER SUPPLY TEST POINTS

(Refer to Wiring Diagram - Power Supply Assembly)

**Note:** Air Pressure Switch must be operated. (Contact COM & NO closed)

All fuses must be good. (F1, F2, F6, F7, F8, F11, F12)

Transformer Thermal Overload (O/L) must be closed.

### Line Voltage at J1 Supply Power In

- Top of fuses F3 & F4 on J1 connector

### Line Voltage on Power Output connector

- Terminals 1 & 2

### 25 VAC Supply to Unit

- Unit Power Plug Terminals 3 & 4
- Unit Power Plug Terminals 7 & 8
- D2 LED is ON

### 20 VAC Supply to Light

- Light Power Plug Terminals 3 & 6
- D1 LED is ON

### 9 VAC Supply to Unit

- Accessories Terminals 1 & 2
- D3 LED is ON

### 5 VDC Supply to USB Hub (only on models 153941-001 & 153941-002)

- USB Hub Power Plug Terminals 1 & 2
- DM4 LED is ON

### 12 VDC Supply to LIN Connections (Chair & Assistant's Unit)

- DM1, DM2, & DM3 LED is ON

### Continuity Check of Transformer's Thermal Overload (O/L)

Continuity should be present at Transformer Brown & Black leads

Light Power J4 Plug	
1	PE GND
2	LIN GND
3	20VAC COM
4	N/A
5	LIN
6	20VAC

Unit Power J5 Plug	
1	PE GND
2	N/A
3	24VAC COM
4	24VAC
5	PE GND
6	N/A
7	24VAC COM
8	24VAC

USB Hub Power	
1	GND
2	5VDC











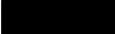













Accessory	
1	9VAC
2	9VAC COM

Power Out	
1	LINE
2	NUETRAL
3	PE GND

Power In	
1	LINE
2	NUETRAL
3	PE GND

[Color Abbreviation Chart](#)

## Color Abbreviation Chart

	Item	Color (English)	Farbe (Deutsch)	Couleur (Français - Europe)	Color (español europeo)	Colore (italiano)	Color (others)
	BK	Black	Schwarz	Noir	Negro	Nero	
	BL	Blue	Blau	Bleu	Azul	Blu	
	BR	Brown	Braun	Marron	Marrón	Marrone	
	CL	Clear	Durchsichtig	Incolore	Transparente	Trasparente	
	GN	Green	Grün	Vert	Verde	Verde	
	GY	Grey	Grau	Gris	Gris	Grigio	
	OR	Orange	Orange	Orange	Naranja	Arancione	
	PR	Purple	Purpur	Pourpre	Morado	Porpora	
	CL/PR	Clear Purple	Durchsichtig Purpur	Incolore Pourpre	Transparente Morado	Trasparente Porpora	
	RD	Red	Rot	Rouge	Rojo	Rosso	
	WH	White	Wei	Blanc	Blanco	Bianco	
	YL	Yellow	Gelb	Jaune	Amarillo	Giallo	
	PK	Pink	Pink	Rose	Rosa	Rosa	
	TN	Tan	Hellbraun	Fauve	Marrón claro	Tanè (marrone scuro)	
	BK/WH	Black/White	Schwarz / Wei	Noir / Blanc	Negro / Blanco	Bianco / Nero	
	BL/WH	Blue/White	Blau / Wei	Bleu / Blanc	Azul / Blanco	Blu / Bianco	
	BR/WH	Brown/White	Braun / Wei	Marron / Blanc	Marrón / Blanco	Marrone / Bianco	
	CL/BK	Clear / Black	Durchsichtig / Schwarz	Incolore / Noir	Transparente / Negro	Trasparente / Nero	
	GN/WH	Green / White	Grün / Wei	Vert / Blanc	Verde / Blanco	Verde / Bianco	
	GN/YL	Green / Yellow	Grün / Gelb	Vert / Jaune	Verde / Amarillo	Verde / Giallo	
	OR/WH	Orange / White	Orange / Wei	Orange / Blanc	Naranja / Blanco	Arancione / Bianco	
	PR/WH	Purple / White	Purpur / Wei	Pourpre / Blanc	Morado / Blanco	Porpora / Bianco	
	RD/WH	Red / White	Rot / Wei	Rouge / Blanc	Rojo / Blanco	Rosso / Bianco	
	VI/WH	Violet / White	Violett / Wei	Violet / Blanc	Violeta / Blanco	Viola / Bianco	
	YL/WH	Yellow / White	Gelb / Wei	Jaune / Blanc	Amarillo / Blanco	Giallo / Bianco	
	YL/GN	Yellow / Green	Gelb / Grün	Jaune / Vert	Amarillo / Verde	Giallo / Verde	
	YL/BK	Yellow / Black	Gelb / Schwarz	Jaune / Noir	Amarillo / Negro	Giallo / Nero	